

KIT SPRINTER with ROOF RAIL

98655-772

FIAMMASTORE

- (DE) VERPACKUNGSINHALT
- (EN) PACKAGE CONTENTS
- (FR) CONTENU DE L'EMBALLAGE
- (ES) CONTENIDO DEL EMBALAJE
- (IT) CONTENUTO DELL'IMBALLO

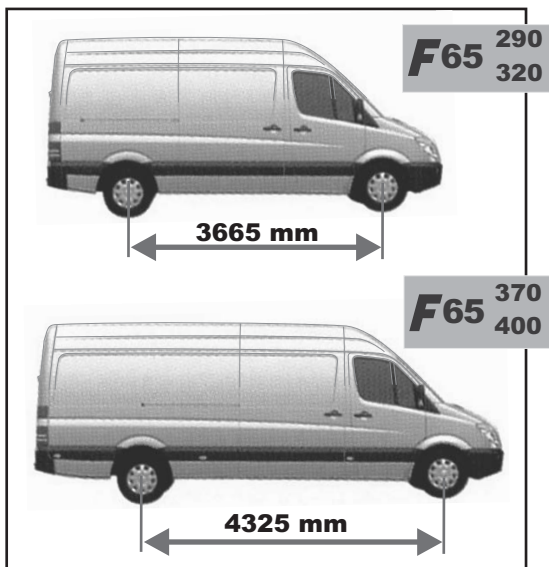
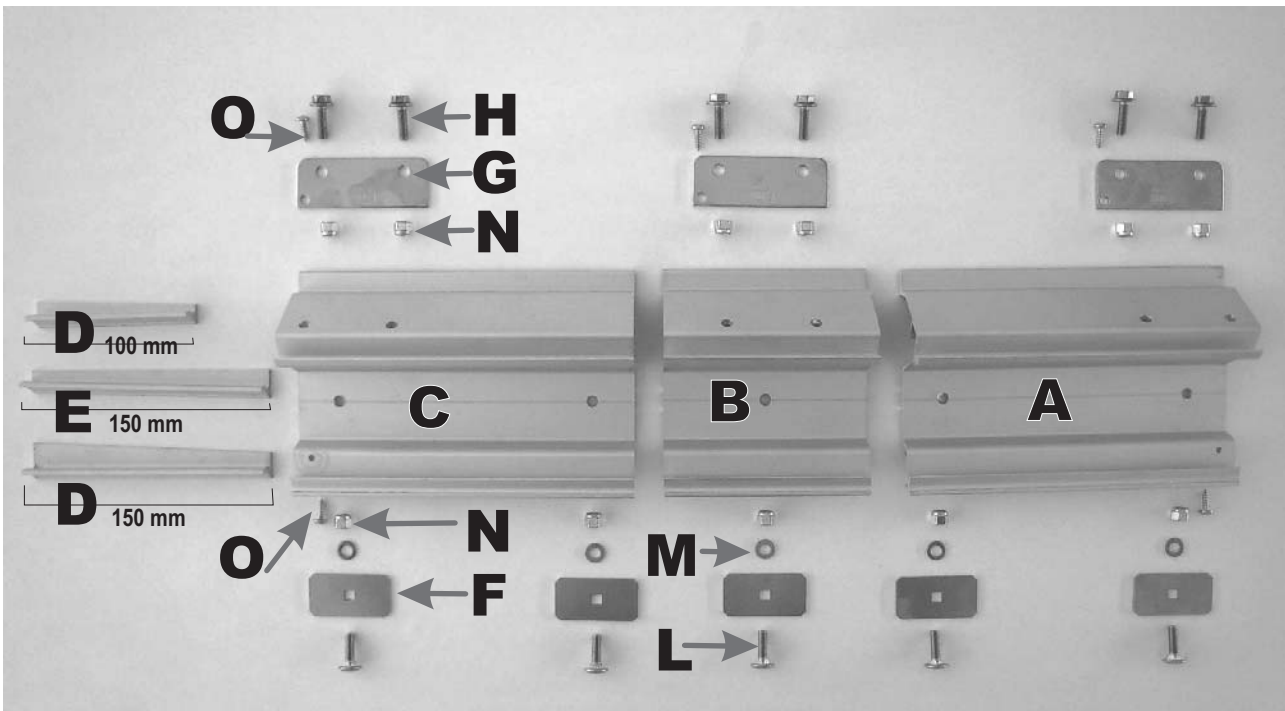
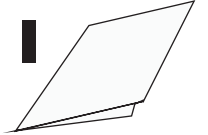

DODGE SPRINTER

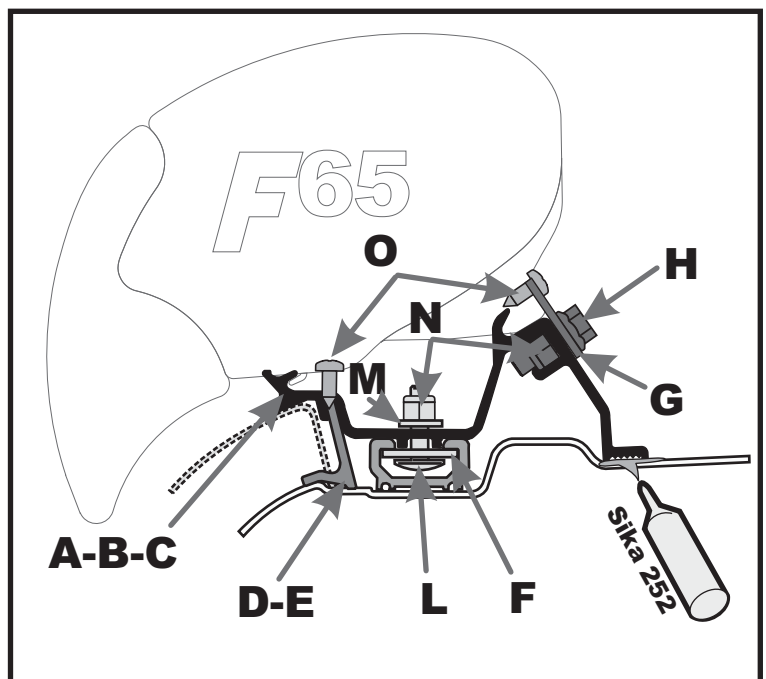

R0_IS_98690-054_revC

- ⒹE Anbringung der Halterungen am Fahrzeug
- ⒺN Installation of the brackets on the vehicle
- ⒻR Installation des pattes sur le véhicule
- ⒺS Instalación de los estribos sobre el vehículo
- ⒻT Montaggio delle staffe sul mezzo

1

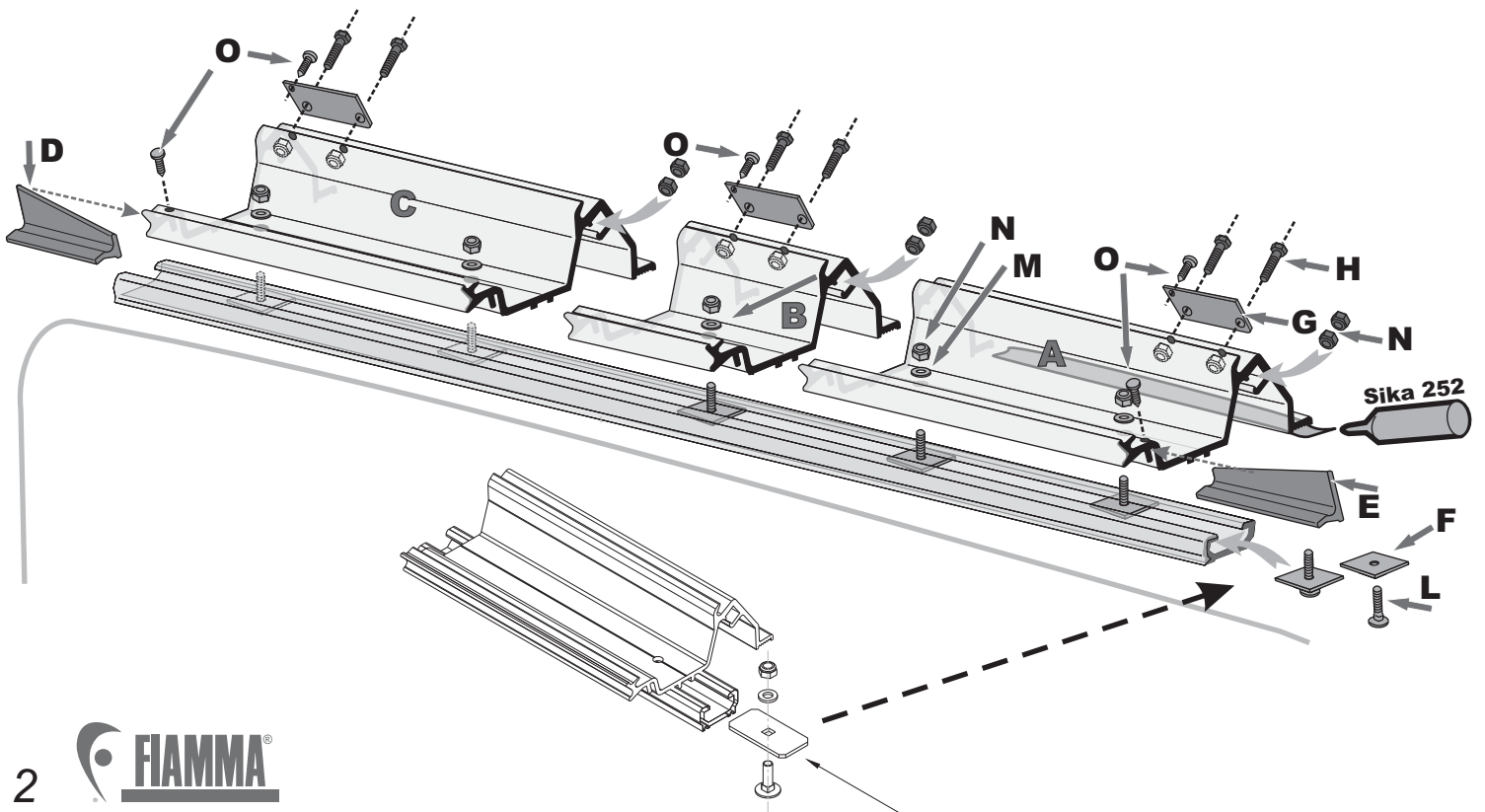
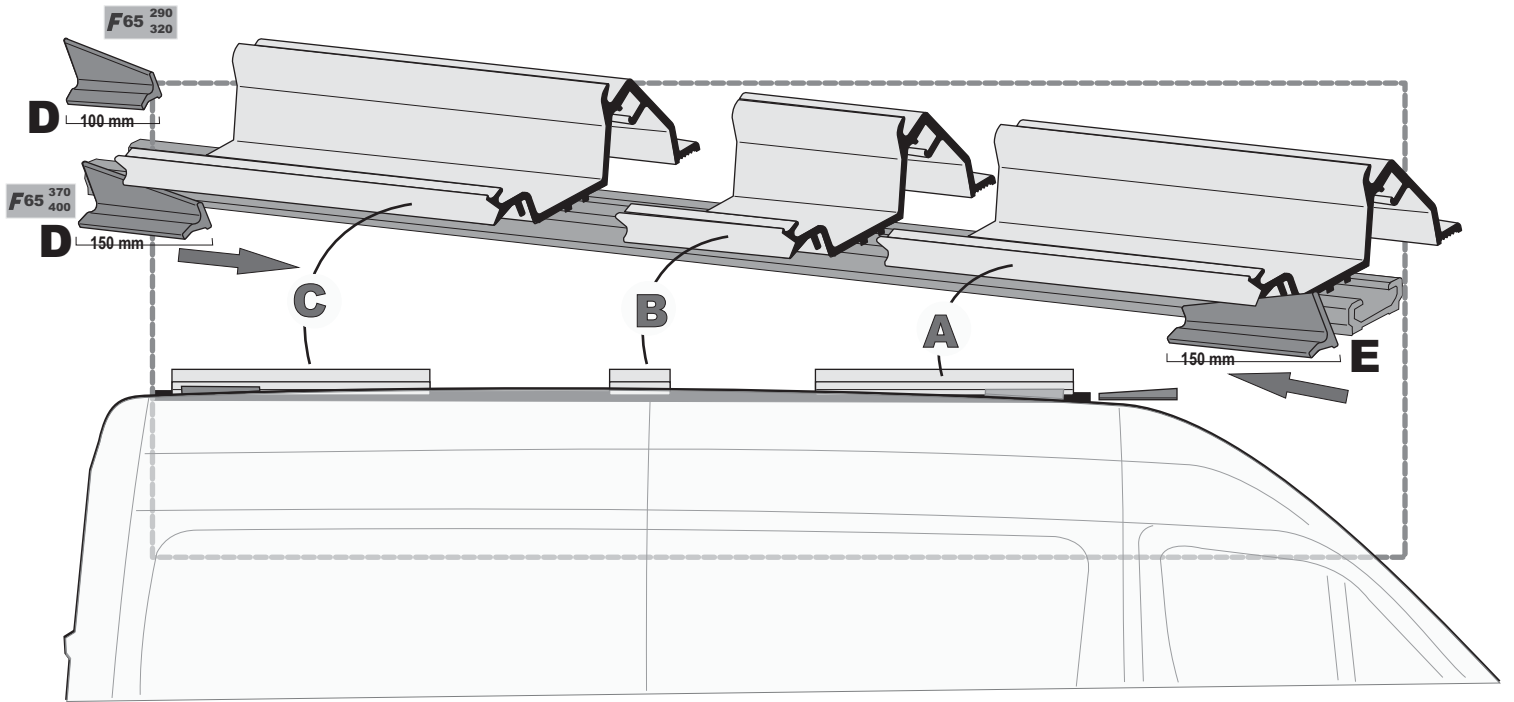
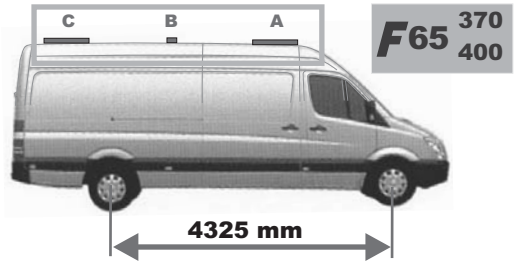
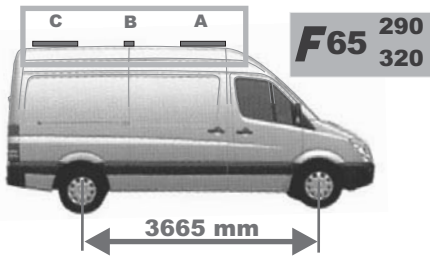

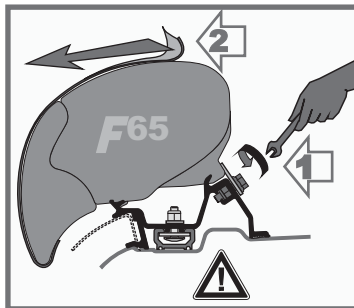
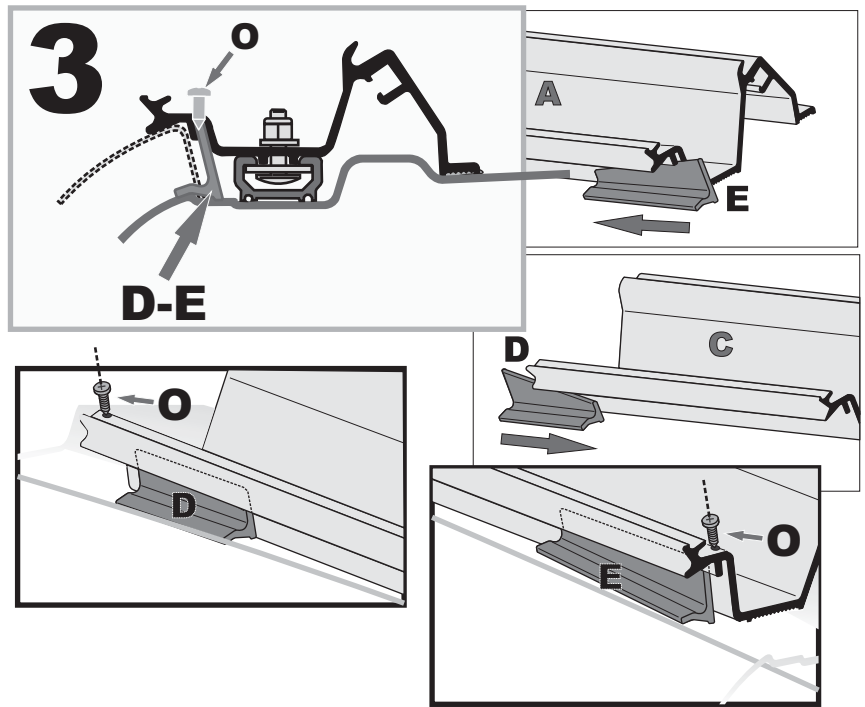
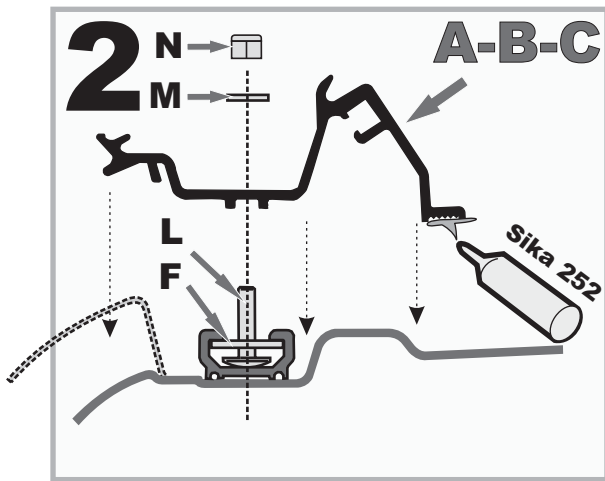

DE Achtung Sicherheit
Entfernen Sie die Etikette nur nachdem die Markise mit der Halterung befestigt wird.

EN Attention Security
Remove this label only after fixing the awning on the bracket.

FR Attention Sécurité
Lever l'étiquette seulement après la fixation du store à l'étrier.

ES Atención-Seguridad
Quitar esta etiqueta solo después de fijar el toldo sobre el estribo.

IT Attenzione Sicurezza
Rimuovere questa etichetta di sicurezza solo dopo aver fissato il tendalino sulla staffa.

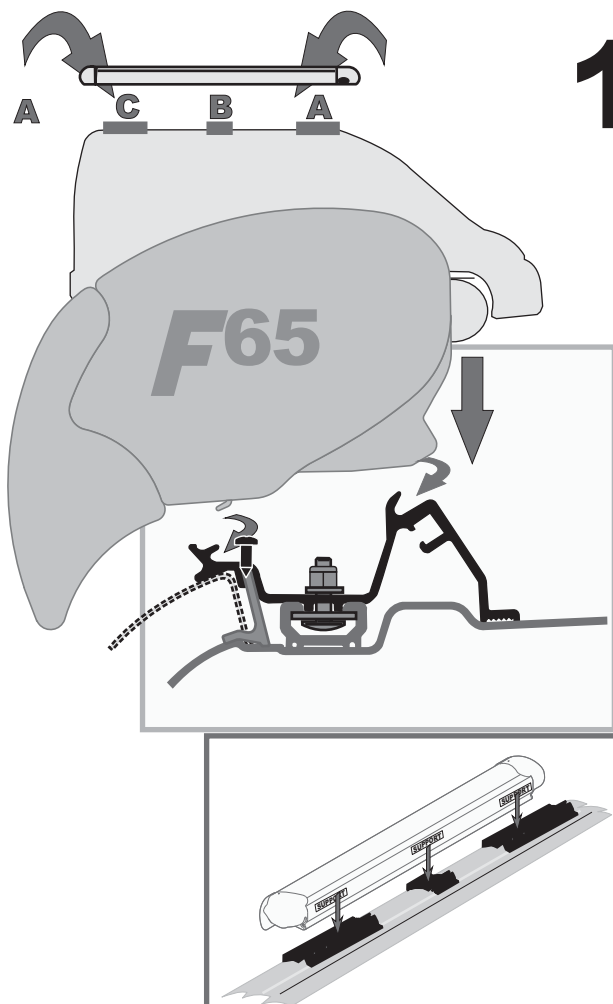

DE Anbringung der Markise auf die Halterungen
EN Installation of the awning on the brackets
FR Installation du store sur les pattes
ES Fijación del toldo sobre los estribos
IT Montaggio del tendalino sulle staffe

- DE** Beim Anbringen der Markise darauf achten, dass sich die Halterungen an den Markierungen "SUPPORT" und an den Anbringungspunkten der Arme im Gehäuse befinden.
- EN** When installing the awning, please make sure that the brackets are in correspondence with the marking "SUPPORT" and in correspondence with the arms fixing points in the box.
- FR** Pendant l'installation du store assurez-vous que les supports soient en correspondance du marquage "SUPPORT" et en correspondance du point de fixation des bras au boîtier.
- ES** Antes que instalar el toldo, verificar que los estribos se encuentren a nivel de la escrita "SUPPORT" y por consiguiente a nivel del punto de fijación de los brazos sobre el armazón.
- IT** Verificare prima dell'installazione del tendalino, che le staffe si trovino in corrispondenza della scritta "SUPPORT" e di conseguenza in corrispondenza al punto di fissaggio delle braccia sul cassonetto.

4

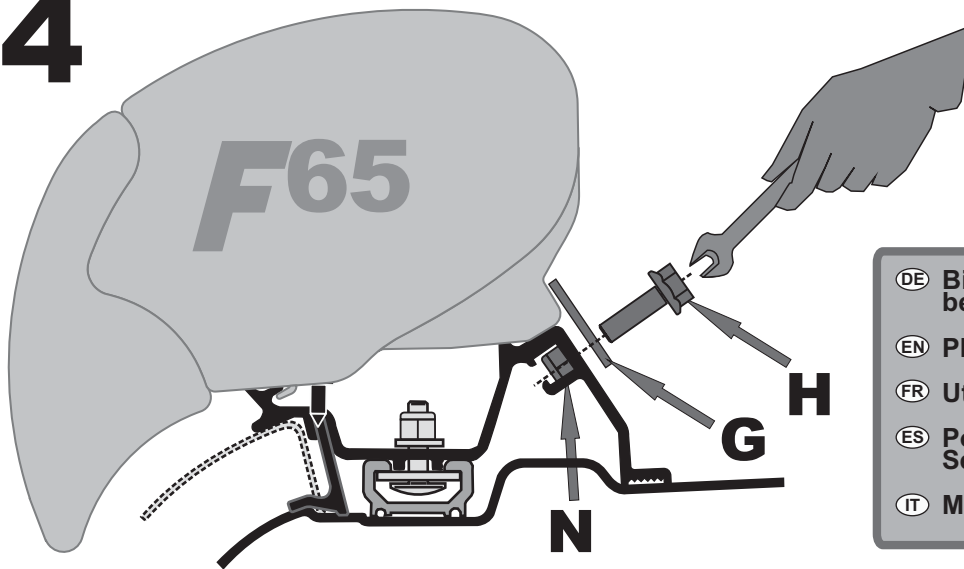

(DE) Bitte immer die Sicherheitsschrauben benutzen.
 (EN) Please use always the security screw.
 (FR) Utilisez toujours les viss de sécurité.
 (ES) Poner siempre los tornillos de Seguridad.
 (IT) Mettere sempre le viti di sicurezza.

5

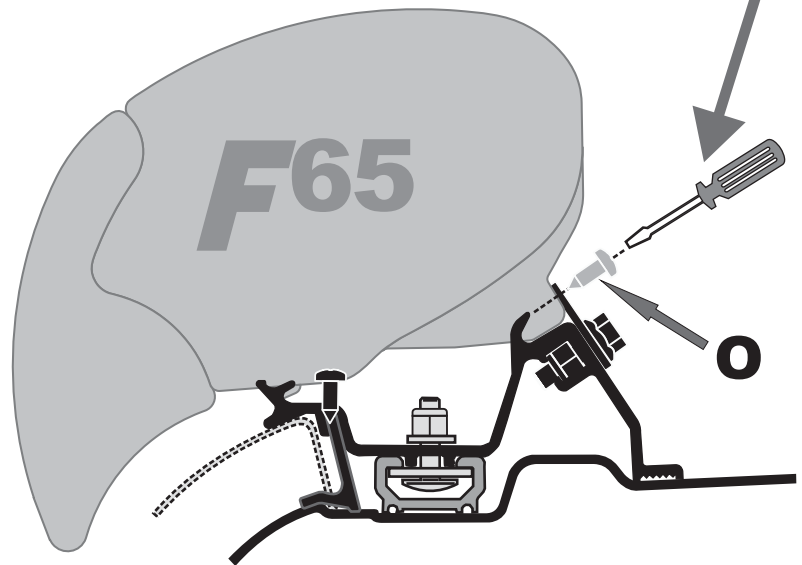

- (DE) **ACHTUNG** - Regelmäßig die Befestigung der Halterungen kontrollieren. Achten Sie vor allem nach dem ersten Sicherstellen darauf, dass sich die Haltebügel nicht verschoben haben.
- (EN) **ATTENTION** - Periodically check the brackets to make sure it is firmly attached (especially after the first kilometers) make sure the belts are not loose and that holding brackets have not shifted.
- (FR) **ATTENTION** - Contrôler périodiquement l'état de fixation des pattes (surtout après les premiers kilomètres) en s'assurant que les supports de fixation n'aient pas bougé.
- (ES) **CUIDADO** - Controlar periódicamente el estado de fijación de los estribos (sobretudo después de los primeros Kms) asegurándose que no se desplacen.
- (IT) **ATTENZIONE** - Controllare periodicamente lo stato di fissaggio delle staffe (soprattutto dopo i primi chilometri) assicurandosi che le stesse non si siano mosse e che i serraggi siano corretti.

- (DE) Bitte halten Sie sich beim Gebrauch der Markise an die Gebrauchsanweisung.
- (EN) When using the awning please follow the instructions of the product.
- (FR) Pour l'utilisation du store, se référer aux instructions du store même.
- (ES) Para el uso del toldo, atenerse a las instrucciones que se encuentran en el producto.
- (IT) Per l'utilizzo del tendalino, attenersi alle istruzioni presenti nel prodotto.

